



**Waukesha  
Cherry-Burrell**  
A United Dominion Company

INLINE

AND

SIDE

ENTRY



**FILTERS & STRAINERS**

# RELIABLE LIQUID FILTRATION



**Inline Strainers**  
1" thru 3"



**Side Entry Strainers**  
1" thru 4"

Waukesha Cherry-Burrell stainless steel filters and strainers offer sanitary, efficient flow design, flexibility in installation and quick and simple cleanup.

Filters provide reliable means of removing fine particles from liquids; filtering media must be removed and disposed periodically. Strainers, on the other hand, actually are coarse filters that remove larger particles; the straining mesh can be reused after cleaning.

## REPLACEMENT PARTS

### HOW TO ORDER

Part nos. shown are for clamp type & Buna N.

For Bevel Connections – Add "T" to Part No. i.e. 129-431TX

For Female Connections – Add "F" to Part No. i.e. 129-431FX

For Male Connections – Add "M" to Part No. i.e. 129-431MX

For Seals & O-Rings in Viton – Add "V" to Part No. i.e. 20-89V

For Seals & O-Rings in EPDM – Add "E" to Part No. i.e. 20-89E

For Seals & O-Rings in Silicone – Add "S" to Part No. i.e. 20-89S

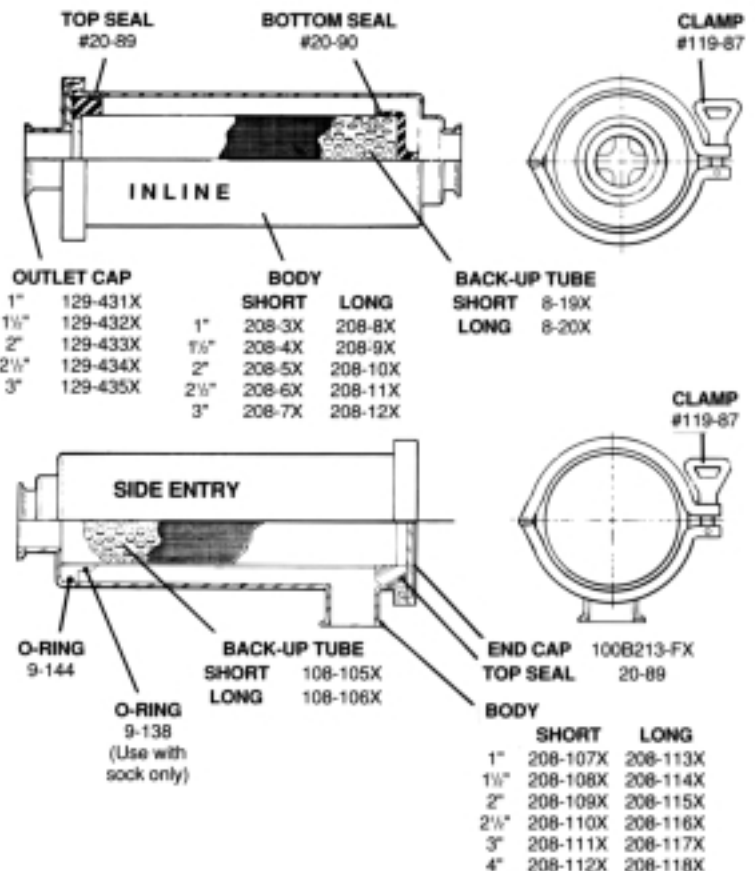

# DIMENSIONS

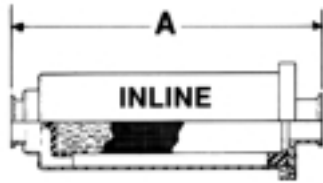
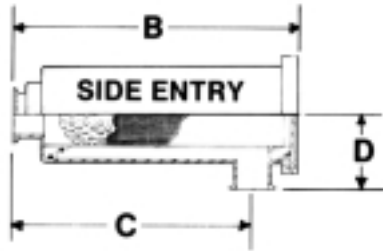

		SHORT			LONG			
		A	B	C	A	B	C	D
CLAMP	1	15 <sup>3</sup> / <sub>4</sub>	14 <sup>1</sup> / <sub>4</sub>	12 <sup>7</sup> / <sub>16</sub>	35 <sup>3</sup> / <sub>8</sub>	33 <sup>13</sup> / <sub>16</sub>	32	3 <sup>1</sup> / <sub>2</sub>
	1 <sup>1</sup> / <sub>2</sub>	15 <sup>3</sup> / <sub>4</sub>	14 <sup>1</sup> / <sub>4</sub>	12 <sup>3</sup> / <sub>16</sub>	35 <sup>3</sup> / <sub>8</sub>	33 <sup>13</sup> / <sub>16</sub>	31 <sup>3</sup> / <sub>4</sub>	3 <sup>1</sup> / <sub>2</sub>
	2	15 <sup>3</sup> / <sub>4</sub>	14 <sup>1</sup> / <sub>4</sub>	11 <sup>11</sup> / <sub>16</sub>	35 <sup>3</sup> / <sub>8</sub>	33 <sup>13</sup> / <sub>16</sub>	31 <sup>1</sup> / <sub>2</sub>	3 <sup>1</sup> / <sub>2</sub>
	2 <sup>1</sup> / <sub>2</sub>	15 <sup>3</sup> / <sub>4</sub>	14 <sup>1</sup> / <sub>4</sub>	11 <sup>7</sup> / <sub>16</sub>	35 <sup>3</sup> / <sub>8</sub>	33 <sup>13</sup> / <sub>16</sub>	31 <sup>1</sup> / <sub>4</sub>	3 <sup>1</sup> / <sub>2</sub>
	3	15 <sup>3</sup> / <sub>4</sub>	14 <sup>1</sup> / <sub>4</sub>	11 <sup>7</sup> / <sub>16</sub>	35 <sup>3</sup> / <sub>8</sub>	33 <sup>13</sup> / <sub>16</sub>	31	3 <sup>1</sup> / <sub>2</sub>
BEVEL	4	N.A.	14 <sup>1</sup> / <sub>4</sub>	10 <sup>15</sup> / <sub>16</sub>	N.A.	33 <sup>13</sup> / <sub>16</sub>	30 <sup>1</sup> / <sub>2</sub>	3 <sup>1</sup> / <sub>2</sub>
	1	16 <sup>3</sup> / <sub>16</sub>	14 <sup>1</sup> / <sub>2</sub>	12 <sup>11</sup> / <sub>16</sub>	35 <sup>13</sup> / <sub>16</sub>	34 <sup>1</sup> / <sub>16</sub>	32 <sup>1</sup> / <sub>4</sub>	3 <sup>3</sup> / <sub>4</sub>
	1 <sup>1</sup> / <sub>2</sub>	16 <sup>5</sup> / <sub>16</sub>	14 <sup>5</sup> / <sub>8</sub>	12 <sup>9</sup> / <sub>16</sub>	35 <sup>15</sup> / <sub>16</sub>	34 <sup>3</sup> / <sub>16</sub>	32 <sup>1</sup> / <sub>8</sub>	3 <sup>7</sup> / <sub>8</sub>
	2	16 <sup>3</sup> / <sub>8</sub>	14 <sup>5</sup> / <sub>8</sub>	12 <sup>1</sup> / <sub>4</sub>	36	34 <sup>3</sup> / <sub>16</sub>	31 <sup>7</sup> / <sub>8</sub>	3 <sup>7</sup> / <sub>8</sub>
	2 <sup>1</sup> / <sub>2</sub>	16 <sup>3</sup> / <sub>4</sub>	14 <sup>7</sup> / <sub>8</sub>	12 <sup>1</sup> / <sub>4</sub>	36 <sup>3</sup> / <sub>8</sub>	34 <sup>7</sup> / <sub>16</sub>	31 <sup>7</sup> / <sub>8</sub>	4 <sup>1</sup> / <sub>8</sub>
FEMALE I	3	17	14 <sup>7</sup> / <sub>8</sub>	12	36 <sup>5</sup> / <sub>8</sub>	34 <sup>7</sup> / <sub>16</sub>	31 <sup>5</sup> / <sub>8</sub>	4 <sup>1</sup> / <sub>8</sub>
	4	N.A.	14 <sup>7</sup> / <sub>8</sub>	11 <sup>1</sup> / <sub>2</sub>	N.A.	34 <sup>7</sup> / <sub>16</sub>	31 <sup>1</sup> / <sub>8</sub>	4 <sup>1</sup> / <sub>8</sub>
	1	16 <sup>9</sup> / <sub>16</sub>	14 <sup>11</sup> / <sub>16</sub>	12 <sup>7</sup> / <sub>8</sub>	36 <sup>3</sup> / <sub>16</sub>	34 <sup>1</sup> / <sub>4</sub>	32 <sup>7</sup> / <sub>16</sub>	3 <sup>15</sup> / <sub>16</sub>
	1 <sup>1</sup> / <sub>2</sub>	16 <sup>13</sup> / <sub>16</sub>	14 <sup>13</sup> / <sub>16</sub>	12 <sup>3</sup> / <sub>4</sub>	36 <sup>7</sup> / <sub>16</sub>	34 <sup>3</sup> / <sub>8</sub>	32 <sup>5</sup> / <sub>16</sub>	4 <sup>1</sup> / <sub>16</sub>
	2	17 <sup>1</sup> / <sub>16</sub>	14 <sup>7</sup> / <sub>8</sub>	12 <sup>9</sup> / <sub>16</sub>	36 <sup>13</sup> / <sub>16</sub>	34 <sup>7</sup> / <sub>16</sub>	32 <sup>1</sup> / <sub>8</sub>	4 <sup>1</sup> / <sub>8</sub>
MALE I	2 <sup>1</sup> / <sub>2</sub>	17 <sup>1</sup> / <sub>2</sub>	15 <sup>3</sup> / <sub>16</sub>	12 <sup>5</sup> / <sub>8</sub>	37 <sup>1</sup> / <sub>8</sub>	34 <sup>3</sup> / <sub>4</sub>	32 <sup>3</sup> / <sub>16</sub>	4 <sup>7</sup> / <sub>16</sub>
	3	18 <sup>1</sup> / <sub>8</sub>	15 <sup>3</sup> / <sub>16</sub>	12 <sup>3</sup> / <sub>8</sub>	38 <sup>1</sup> / <sub>2</sub>	34 <sup>3</sup> / <sub>4</sub>	31 <sup>15</sup> / <sub>16</sub>	4 <sup>7</sup> / <sub>16</sub>
	4	N.A.	15 <sup>3</sup> / <sub>16</sub>	11 <sup>7</sup> / <sub>8</sub>	N.A.	34 <sup>3</sup> / <sub>4</sub>	31 <sup>7</sup> / <sub>16</sub>	4 <sup>7</sup> / <sub>16</sub>
	1	16 <sup>3</sup> / <sub>4</sub>	14 <sup>5</sup> / <sub>16</sub>	12 <sup>1</sup> / <sub>2</sub>	36 <sup>3</sup> / <sub>16</sub>	33 <sup>7</sup> / <sub>8</sub>	32 <sup>1</sup> / <sub>16</sub>	3 <sup>9</sup> / <sub>16</sub>
	1 <sup>1</sup> / <sub>2</sub>	16 <sup>9</sup> / <sub>16</sub>	14 <sup>7</sup> / <sub>16</sub>	12 <sup>3</sup> / <sub>8</sub>	36 <sup>7</sup> / <sub>16</sub>	34	31 <sup>15</sup> / <sub>16</sub>	3 <sup>11</sup> / <sub>16</sub>
2	16 <sup>15</sup> / <sub>16</sub>	14 <sup>3</sup> / <sub>8</sub>	12	36 <sup>13</sup> / <sub>16</sub>	33 <sup>15</sup> / <sub>16</sub>	31 <sup>5</sup> / <sub>8</sub>	3 <sup>5</sup> / <sub>8</sub>	
2 <sup>1</sup> / <sub>2</sub>	17 <sup>3</sup> / <sub>16</sub>	14 <sup>9</sup> / <sub>16</sub>	12	37 <sup>1</sup> / <sub>8</sub>	34 <sup>1</sup> / <sub>8</sub>	31 <sup>9</sup> / <sub>16</sub>	3 <sup>13</sup> / <sub>16</sub>	
3	18 <sup>9</sup> / <sub>16</sub>	14 <sup>9</sup> / <sub>16</sub>	11 <sup>3</sup> / <sub>4</sub>	38 <sup>1</sup> / <sub>2</sub>	34 <sup>1</sup> / <sub>8</sub>	31 <sup>5</sup> / <sub>16</sub>	3 <sup>13</sup> / <sub>16</sub>	
4	N.A.	14 <sup>9</sup> / <sub>16</sub>	11 <sup>1</sup> / <sub>4</sub>	N.A.	34 <sup>1</sup> / <sub>8</sub>	30 <sup>13</sup> / <sub>16</sub>	3 <sup>13</sup> / <sub>16</sub>	

# PROPER FILTERING TIPS

These filter or strainer types are designed primarily for removal of particles of various sizes from a product. They are not intended to remove odors or impurities.

Actual performance figures would be rather difficult to offer here. Capabilities vary according to line pressure, size and amount of particles in product, etc.

**A PRESSURE DROP THROUGH THE UNIT OF 2 TO 5 PSI OVER NORMAL MEANS FILTER MEDIA SHOULD BE CHANGED!**

Protect unit from damage when used with high speed or positive pump by using by-pass or pressure relief system.

# SOCK & MESH RATING & REPLACEMENTS



ORDER NUMBER			
Socks	Short	Long	Micron Rating
Cotton	8-23	8-26	513
Nylon	8-24	8-27	800
Tuffly	8-25	8-28	38

ORDER NUMBER						
MESH	SHORT	LONG	MICRON RATING	SPACE BET. WIRES	% OPEN	WIRE SIZE
6	8-137X	8-138X	3353	0.132	62.7	0.035
8	8-130X	8-131X	2540	0.100	64.0	0.025
10	8-126X	8-127X	1905	0.075	56.3	0.025
12	8-132X	8-133X	1524	0.060	51.8	0.023
16	8-83X	8-84X	1130	0.045	50.7	0.018
20	8-29X	8-30X	864	0.034	46.2	0.016
30	8-85X	8-86X	533	0.021	40.8	0.012
40	8-13X	8-16X	381	0.015	36.0	0.010
50	8-128X	8-129X	280	0.011	30.3	0.009
60	8-31X	8-32X	229	0.009	30.5	0.008
80	8-14X	8-17X	178	0.007	31.4	0.006
100	8-33X	8-34X	140	0.006	36.0	0.004
150	8-15X	8-18X	104	0.004	37.4	0.003
200	8-103X	8-104X	73	0.003	33.6	0.002
325	8-119X	8-120X	43	0.002	30.0	0.014

Pressure rating: 200 PSI @ 70 deg. F  
 Filter Area - Short:: 1 sq. ft. (0.65 actual)  
 Long: 2 sq. ft. (1.94 actual)

## ORDERING INSTRUCTIONS

For ease in ordering, please make a copy of the opposite side of this page, fill in **ALL** the boxes and fax it to your distributor or to the factory.

Use a separate sheet for each unit that has different features.

For Step 5 & 6, (Other Connections), please provide detail or sketch of end connections.

# ORDERING INSTRUCTIONS

<b>W</b>	<b>Style</b>	<b>Size</b>	<b>Length</b>	<b>End Connection</b> (Fill in Symbol)	<b>Perforated Back-up Tube</b>	Choose only One		<b>Seals</b>
	In-Line (25) Side Entry (25E)	1" (10) 1.5" (15) 2" (20) 2.5" (25) 3" (30) 4" (40) Side entry only	Short (S) Long (L)	In      Out	1/4" (4) 1/8" (8)	Tuffy (T) Nylon (N) Cotton (C)	6 Mesh 8 Mesh 10 Mesh 12 Mesh 16 Mesh 20 Mesh 24 Mesh 30 Mesh 40 Mesh 50 Mesh 60 Mesh 80 Mesh 100 Mesh 150 Mesh 200 Mesh 325 Mesh	Buna (B) Viton (V) EPDM (E)

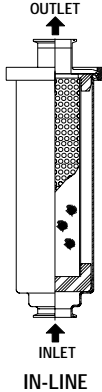

IN-LINE

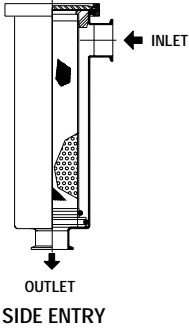

SIDE ENTRY

CONNECTION TYPE	SYMBOL	CONNECTION TYPE	SYMBOL
BUTT-WELD	W	Q-LINE	Q
S-LINE	C	THREADED	T
FEMALE I-LINE	FI	DIN 11851SC	D
MALE I-LINE	MI	OTHER	X

## How to Order

Step #1 Model "W"

Step #2 Style: 25 = In-line (Choose only one)  
25E = Side entry

Step #3 Size: (Fill in size required)

Step #4 Length: Fill in either (S) or (L)

Step #5 & 6 End connection: Inlet/Outlet (Fill in symbol from chart)

Step #7 Perforated back-up tube: Fill in either (4) or (8)

Step #8 & 9 Sock/Mesh (Choose only one, then fill in the appropriate symbol for sock or fill in the mesh number) **Do not fill in both boxes**

Step #10 Seals: Fill in either (B), (V) or (E)

**Sample number for an In-line, 2", long, S-line (both ends), 1/4" back-up tube, 30 Mesh, & Viton seals = W2520LSS430V**

Distributor \_\_\_\_\_

User \_\_\_\_\_

Quantity \_\_\_\_\_ Date \_\_\_\_\_

Notes \_\_\_\_\_

\_\_\_\_\_

\_\_\_\_\_

# FILTER/STRAINER PRESSURE DROP CURVE

For long and short units

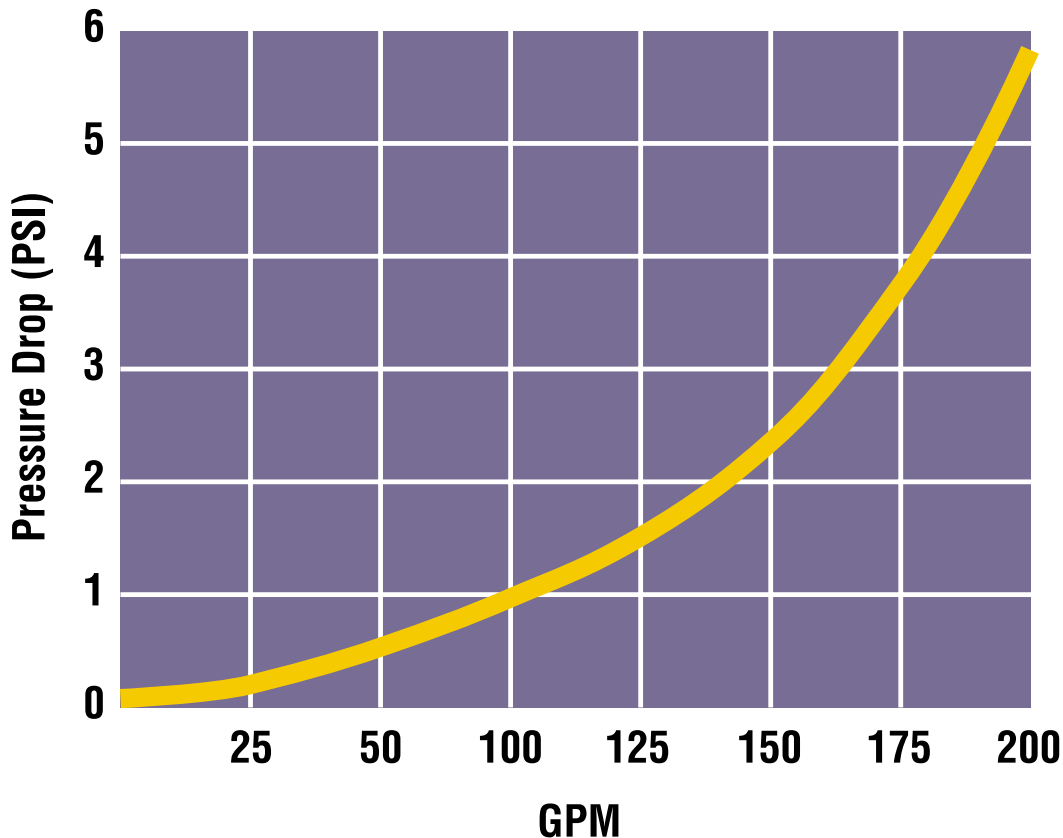

Curve is based on water  
Short version max. flow 125 gpm  
Long version max. flow 200 gpm

## WAUKESHA CHERRY-BURRELL WARRANTY

Seller warrants its products to be free from defects in materials and workmanship for a period of one (1) year from the date of shipment. This warranty shall not apply to products which require repair or replacement due to normal wear and tear or to products which are subjected to accident, misuse or improper maintenance. This warranty extends only to the original Buyer. Products manufactured by others but furnished by Seller are exempted from this warranty and are limited to the original manufacturer's warranty.

Waukesha Cherry-Burrell  
611 Sugar Creek Road  
Delavan, WI 53115 USA  
Tel: 1-800-252-5200 or 262-728-1900  
Fax: 1-800-252-5012 or 262-728-4904  
E-mail: [custserv@gowcb.com](mailto:custserv@gowcb.com)  
Web site: [www.gowcb.com](http://www.gowcb.com)

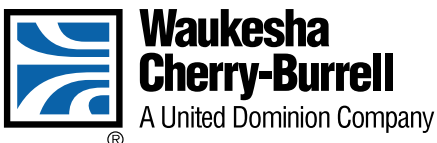

FH-1843  
TA-2M-400JA  
Printed in U.S.A.  
Effective 7/98