

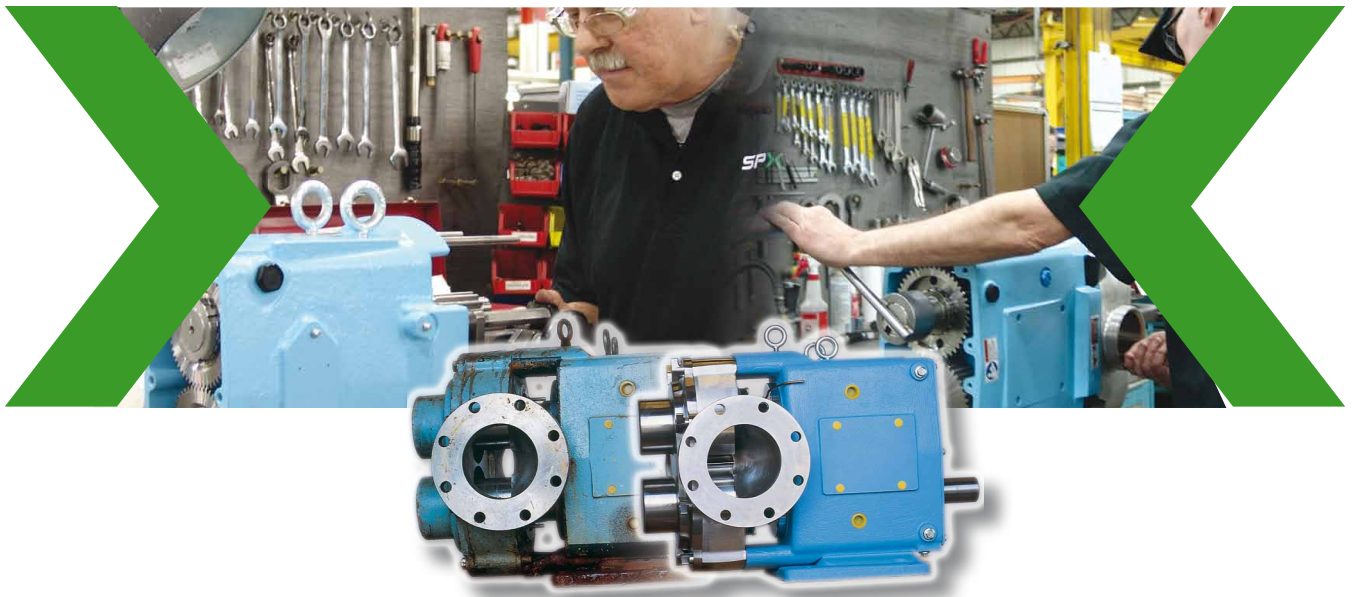

# Universal Pump Extended Life Program Remanufacturing, Reconditioning and Repair



# SPX Extended Life Program

## Increasing the Value of Your Investment

When you invest in a Waukesha Cherry-Burrell Universal pump SPX is committed to maximizing its lifetime value. Our goal is to use our unique capabilities to help you get the most out of your equipment. From fully warranted factory remanufacturing to customized repair, the SPX team is ready to provide the services best matched to your needs.



## Full Remanufacturing with Factory Warranty

- Complete factory remanufacturing to two standard oversized dimensions
- Restores pump to original factory specifications
- Limits number of rotor sizes in your facility
- Includes new shafts, gears, bearings, seals and rotors
- Backed by same factory warranty as a new pump
- Standardized pricing
- Exchange program available on most common models

## Inspect and Advise Programs

### Custom Reconditioning

- Custom reconditioning provides multiple potential lives depending upon pump wear
- Pump is remachined the minimum amount required
- Rotors, shafts, seals and gears are replaced with new as needed
- Restores pump to maximum operating capacity
- Mechanical and performance warranties provided

### Factory Repair Service

Pump repair to your specific requirements

- Pump is inspected by factory personnel
- Report provided advising of recommended repairs
- Repairs made as agreed per the quotation
- Mechanical warranty provided

# The Authentic Remanufacture Story

## From Out of Spec to New Factory Warranty

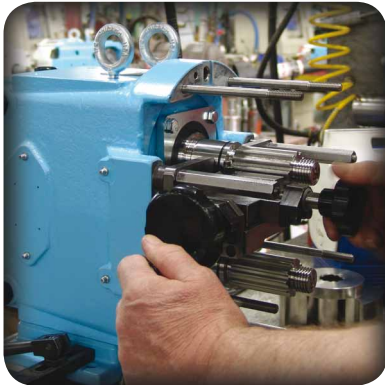

Pump wear is unpredictable. Pitting, grooves and erosion wear is carefully machined to standard oversized dimensions by experienced technicians using precision equipment.

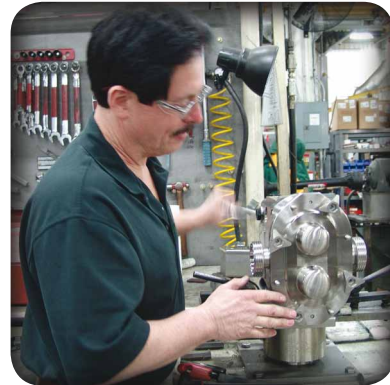

Remanufacturing at SPX Flow Technology follows exacting procedures with standardized parts and tolerances; a total, quality remanufacture.

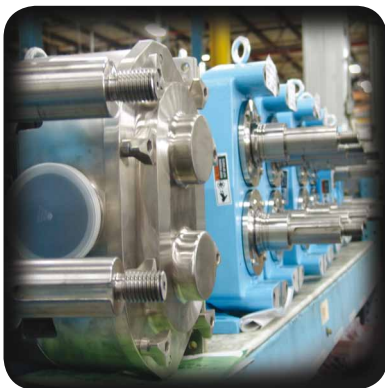

Our remanufacturing facilities maintain extensive inventory of parts that meet our demanding remanufacture tolerances, such as standard oversize rotors, shafts and pump bodies.

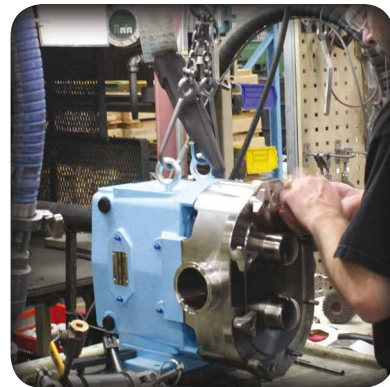

After final assembly, a Waukesha Universal remanufactured pump is performance tested and granted a full factory warranty. You get the same quality and reliability of a new pump at substantial savings in cost.

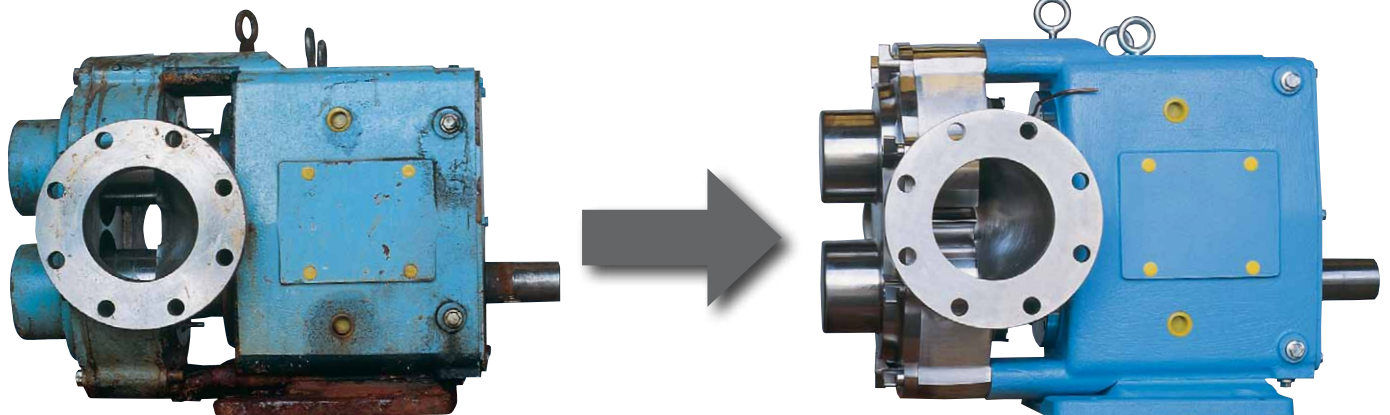

Don't risk downtime. Rely on the Original Manufacturer.

# Your Waukesha rotary positive displacement pump has **THREE** factory warranted lives!

Remanufacturing includes:

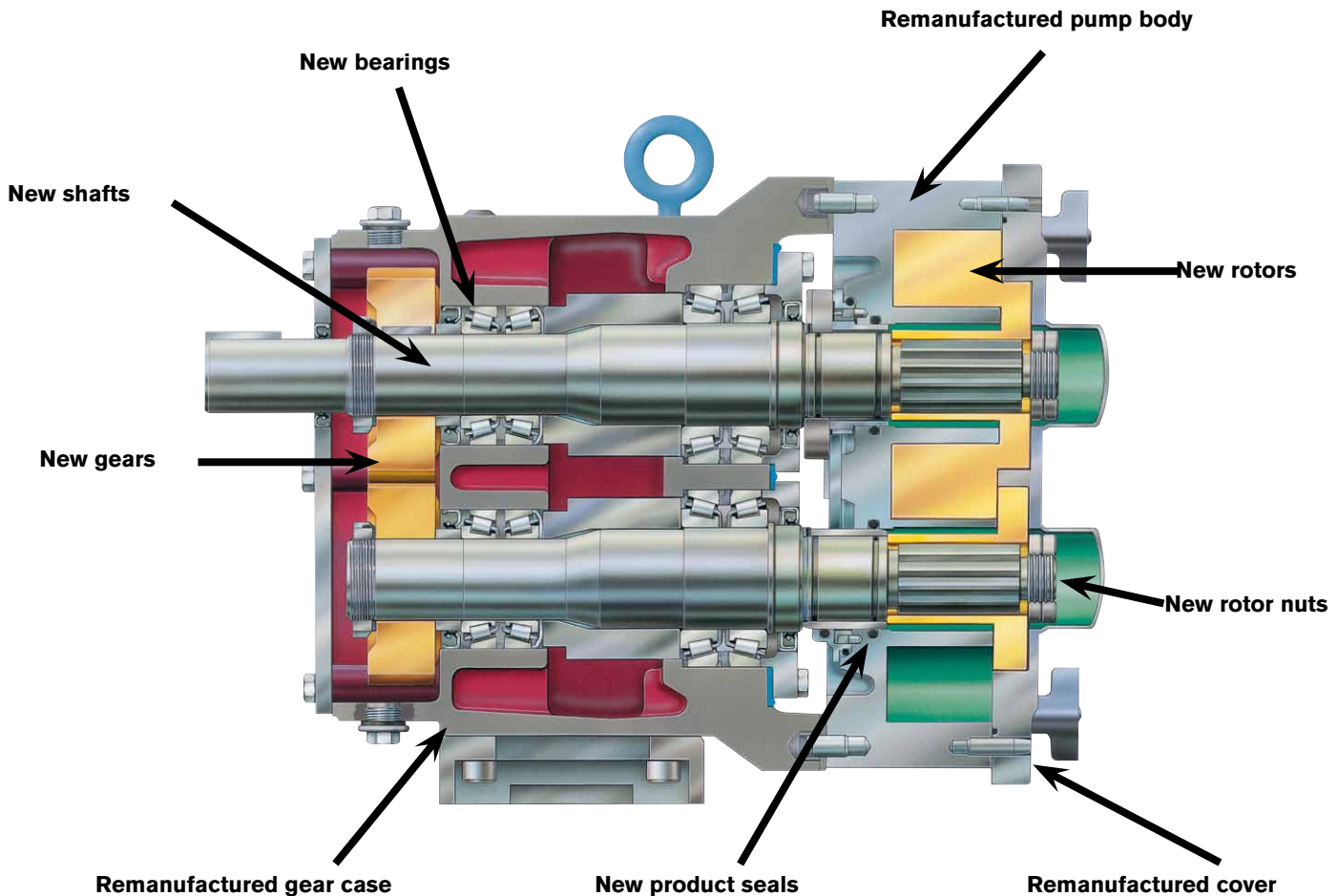

The remanufacture program provides the customer with **standard** oversized tolerances. This option maximizes interchangeability of parts within the customer's operation.

The remanufacture process includes:

- Precision machining of body and cover to **standardized oversize** dimensions.
- New rotors machined to restore original clearances.
- Complete replacement with all new components identified in the illustration above; all replacement parts are manufactured to factory specifications.
- Assembly of pump by factory trained technicians.
- All pumps are tested to validate performance.

Remanufacture is offered **without seals on select pump models**, if requested.

Remanufacture also is offered **with commercially available seals**.

The **remanufacture exchange program** allows you to receive your newly remanufactured pump prior to returning your worn pump. **No downtime.**

# Increase the useable life of your Waukesha rotary positive displacement pump!

## The Inspect and Advise Program:

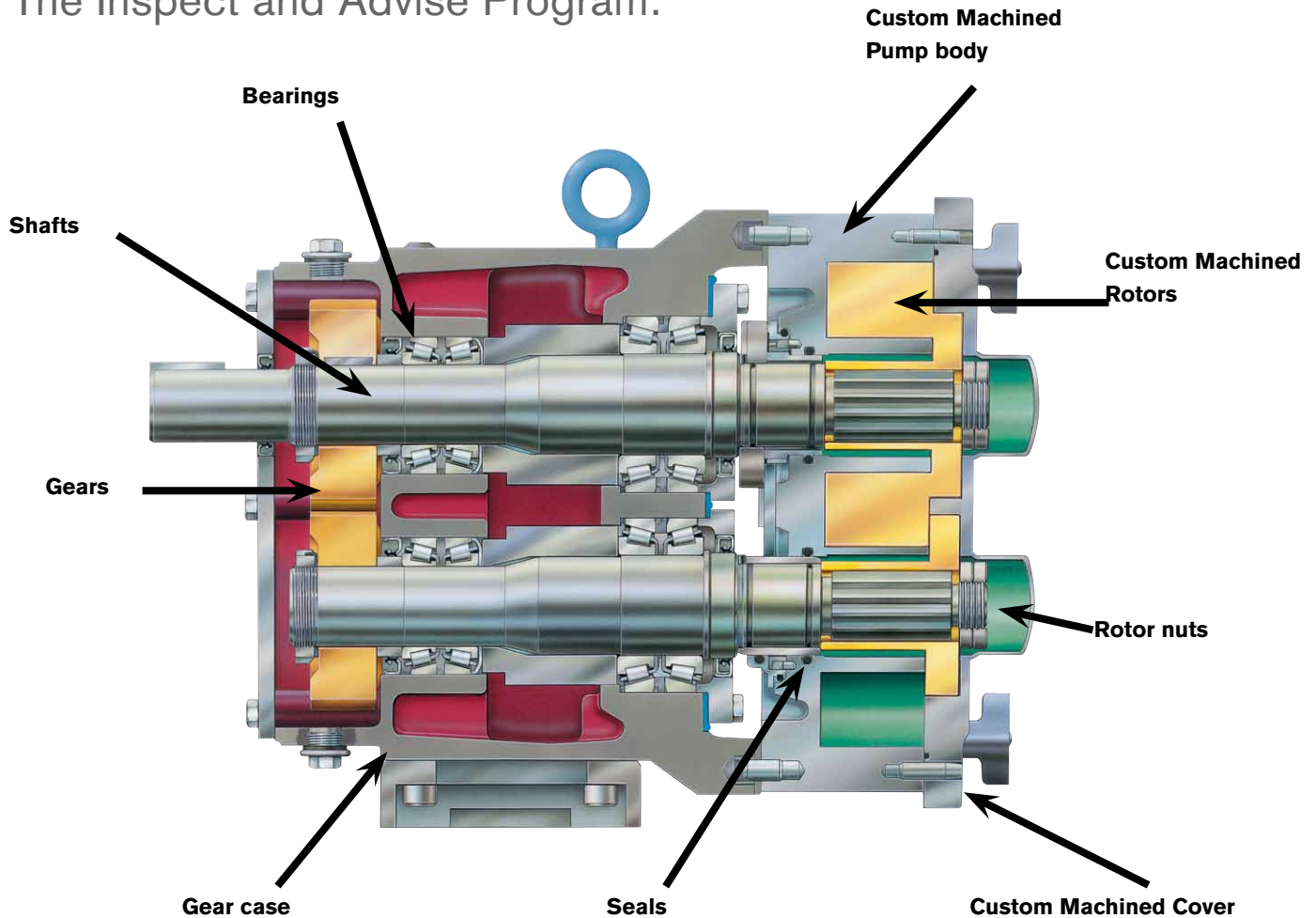

An inspect and advise program provides a **custom** repair or reconditioning after consultation with factory trained technicians. This option enhances the life of your pump.

- A dedicated repair cell provides diagnostic service.
- The pump is inspected and evaluated by factory trained technicians.
- The recommended repair could follow one of two paths:

### 1- Custom Reconditioning

- Custom machine body and/or restore clearances.
- Replace rotors, shafts and seals as necessary.
- Restore pump to operational efficiency.
- Provide mechanical and performance warranty.
- Provides multiple reconditionings.

### 2 - Repair

- Replace non-serviceable parts.
- Restore mechanical operation.
- Provide mechanical warranty.

# Why Use SPX?

- OEM parts assure proper fit and performance
- Work performed by experienced technicians trained by SPX
- Large inventory of pumps and parts to insure quick turnaround
- Backed by engineering and support of world class organization
- Focus on Universal pumps means deep experience and specialized equipment to provide the best results
- Each pump is performance tested
- Full factory warranty
- Full remanufacturing capability for Tru-Fit and ISR integral drives

## Remanufacture Exchange Program

The remanufacture exchange program allows you to receive your newly remanufactured pump prior to returning your own pump.

- No downtime
- Reduces your inventory requirement
- Faster turnaround – Cuts shipping time
- Available on most common models

## Gold Seal Quality Program

The Gold Seal Program was initiated to assure that each remanufactured pump is of OEM quality.

The Gold Seal commitment is to provide you with a zero defect product every time.

- Genuine OEM parts
- Documented performance test
- Verified and repeatable manufacturing processes
- Quality certification – Unique in the industry
- Guaranteed warranty



## SPX Certified Pump Repair Centers

- Local distributors with factory trained and certified service technicians.
- Quick local response.
- Genuine SPX parts.
- Flexible repair programs to meet your needs.
- Local warranty.

# Behind every Waukesha Universal Pump

## Engineering

Research, design and application engineers at SPX Flow Technology possess extensive backgrounds in their respective fields. You can draw on this experience to solve pumping problems or to counsel on process systems design. The imagination and resourcefulness of our engineers have often helped improve our customers' profits through production efficiencies.



## Testing

Ideas do not remain abstract long at SPX Flow Technology. Application of our products to our customer's specific needs often requires practical testing using real-world parameters. We have a fully equipped and staffed facility for this purpose. For example, the Rheology Laboratory tests applications involving highly viscous fluids.

## Sales & Service Network

SPX Flow Technology's trained sales and application engineers are always available for personal consultation to help solve any installation or operational problem. A large number of fully trained SPX stocking distributors throughout the country and around the world provide quality Waukesha Universal replacement parts and service.



## Quality Control

To maintain the product line's reputation for quality and to assure that every unit is shipped "ready to install," each Waukesha pump is thoroughly inspected at every stage of manufacturing and assembly and then tested for design specification.

## Metallurgical Control

SPX's reputation for pump reliability under severe operating conditions is directly related to carefully controlled casting production and consistency of metallurgical properties. It is this control that assures castings of uniform analysis that will perform dependably under all operating conditions.

## **SPX (Waukesha Cherry-Burrell) Warranty**

Seller warrants its products to be free from defects in materials and workmanship for a period of one (1) year from the date of shipment. This warranty shall not apply to products which require repair or replacement due to normal wear and tear or to products which are subjected to accident, misuse or improper maintenance. This warranty extends only to the original buyer. Products manufactured by others but furnished by seller are exempted from this warranty and are limited to the original manufacturer's warranty.



Your local contact:



SPX Flow Technology  
611 Sugar Creek Road  
Delavan, WI 53115  
Phone: (262)728-1900 or (800)252-5200 Fax: (262)728-4904 or (800)252-5012  
E-mail: [wcb@spx.com](mailto:wcb@spx.com)  
[www.gowcb.com](http://www.gowcb.com)  
[www.spxft.com](http://www.spxft.com)

For more information about our worldwide locations, approvals, certifications, and local representatives, please visit [www.spxft.com](http://www.spxft.com).

SPX Corporation reserves the right to incorporate our latest design and material changes without notice or obligation.

Design features, materials of construction and dimensional data, as described in this bulletin, are provided for your information only and should not be relied upon unless confirmed in writing.